

# 4K Cropping Box

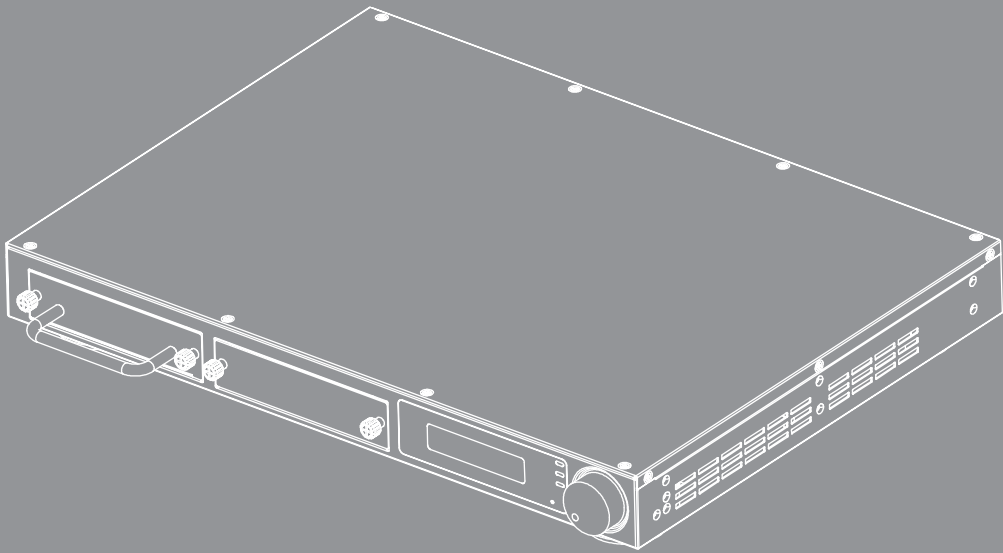

# Table of Contents

1	INTRODUCTION.....	3
2	FEATURES .....	3
3	SPECIFICATIONS .....	4
3.1	CS200T Main Box Specification.....	4
3.2	CS200T Module & Model List .....	5
4	CONNECTION DIAGRAM.....	7
5	PANEL DESCRIPTIONS .....	8
5.1	Front Panel.....	8
5.2	Rear Panel.....	9
6	OPERATION APPROACH.....	10
6.1	Knob Control.....	10
6.1.1	LCM Menu Tree .....	11
6.1.2	Initial Page .....	12
6.1.3	Startup Page .....	12
6.1.4	Main Page Flow.....	12
6.1.5	Information Page .....	13
6.1.6	Network Page.....	14
6.1.7	Video Page .....	15
6.1.8	Audio Page.....	15
6.1.9	Cropping Page.....	16
6.1.9.1	Layout & Overlap Description .....	17
6.1.10	Options Page .....	18
6.1.10.1	Standby and Signal Power On Description.....	18
7	Regulation & Safety Notices .....	19

# 1 INTRODUCTION

CS200T Video Processor is dedicated to image cropping application. CS200T is modular design for flexibility and loop out function for high expandability to achieve different applications. Base on "Everything on LAN" concept, CS200T achieve image blending system installation and maintenance.

## 2 FEATURES

- Up to 4K@60Hz input resolution
- Up to 4 ports 1920x1200@60Hz output resolution
- Image Cropping
- Stereo Audio Output and Input
- Audio pass-through or mixer mode to HDMI output ports
- HDMI 2.0 Loop through port for image cascade to next CS200T
- Modular design for cropping/HDBaseT function
- DHCP for IP setting
- Built in Ethernet Switch



# 3 SPECIFICATIONS

## 3.1 CS200T Main Box Specification

<b>Interface</b>	
<b>Input</b>	<b>Specification</b>
Interface	HDMI
Standard	HDMI 2.0, HDCP 2.2
Resolution	Up to 4K@60Hz, Support specified resolution
Port Number	1
Loop Out Standard	HDMI 2.0, HDCP 2.2
Audio Input	Stereo L/R Line In
<b>Output</b>	<b>Specification</b>
Interface	HDMI / RJ45
Standard	HDMI 1.4a, HDCP 1.4 / HDBaseT 1.0
Output Resolution	Up to WUXGA@60Hz (1920x1200)
Number	2 (default), can be extended to 4
Audio Output	Stereo L/R Line Out
<b>General</b>	
Control Interface	LAN x 2, RS232, LCM & Knob
LAN Cascade	Support, Ethernet Switch inside
Sub-module Qty.	2 Insertion Slots
Cropping Layout	1x2 / 2x2 / 1x3 / 1x4
Overlap Percentage/ Pixel	H/V Output resolution pixel* (0~100%)
Power Consumption	< 80W @ 100~240V AC
Product Dimension	425x313x44.5 mm (WxDxH)

Note: CS200T can be extended to 4 channels output by using two CRPT-2K modules.

## 3.2 CS200T Module & Model List

Unit Product	Description	Note
<b>Main Box</b>	Cropping Main Box	
<b>CRPT-2K</b>	2K Cropping Module – HDMI / HDBaseT out (2 CH)	

Model Name	Description	Note
<b>CS200T</b>	Main Box + 1 x CRPT-2K (For Projector W/ Warping & Blending function)	 <p>The image shows two components: a black trapezoidal main box at the top and a blue CRPT-2K module at the bottom. The CRPT-2K module is a printed circuit board with various electronic components and a connector at the bottom.</p>

Note: CS200T can be extended to 4 channels output by using two CRPT-2K modules.

# 4 CONNECTION DIAGRAM

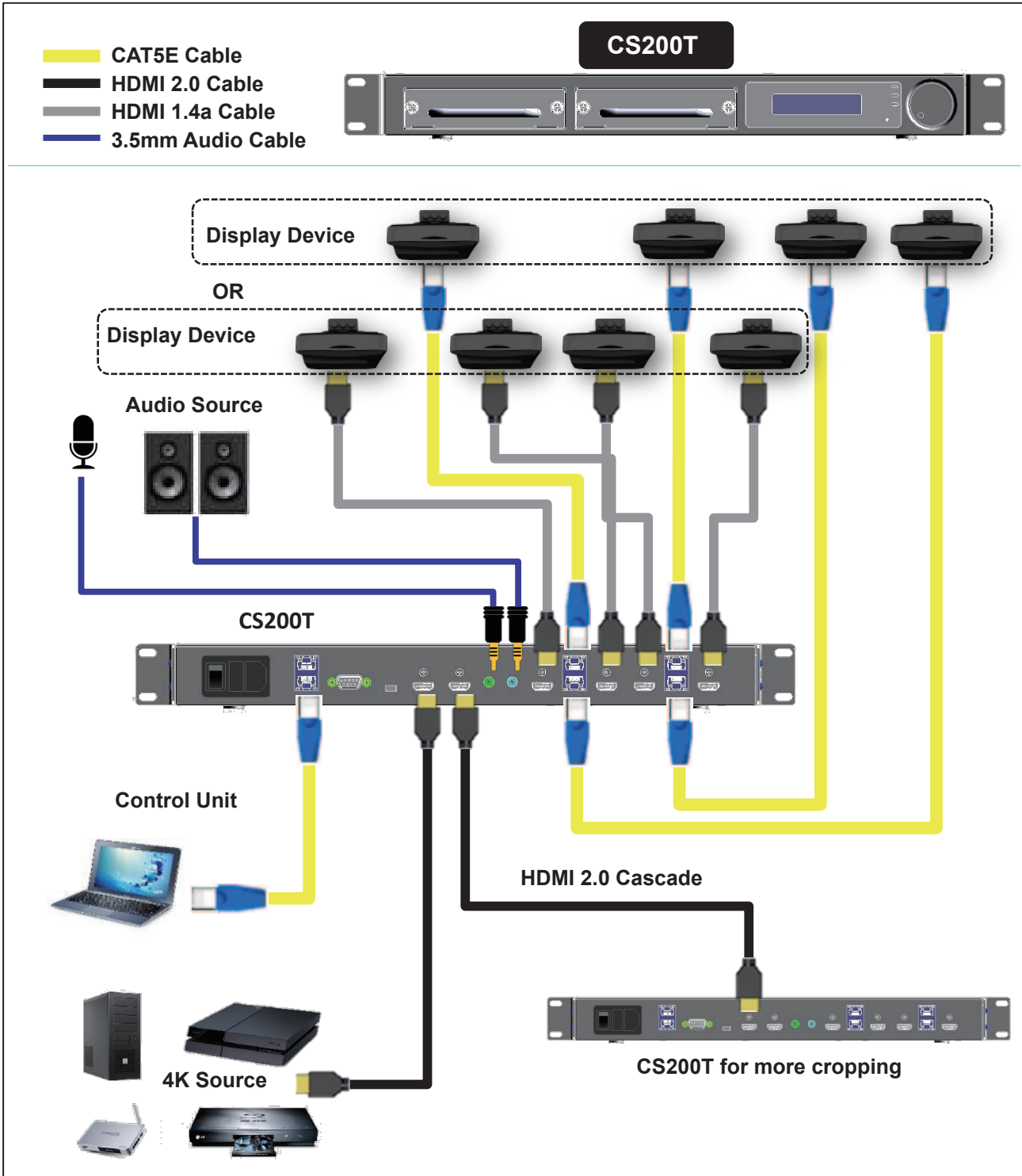

Note1: CS200T can be extended to 4 channels output by using two CRPT-2K modules.

Note2: CS200T with Ethernet Hub inside for cascading the LAN ports of 2 units of CS200T.

# 5 PANEL DESCRIPTIONS

## 5.1 Front Panel

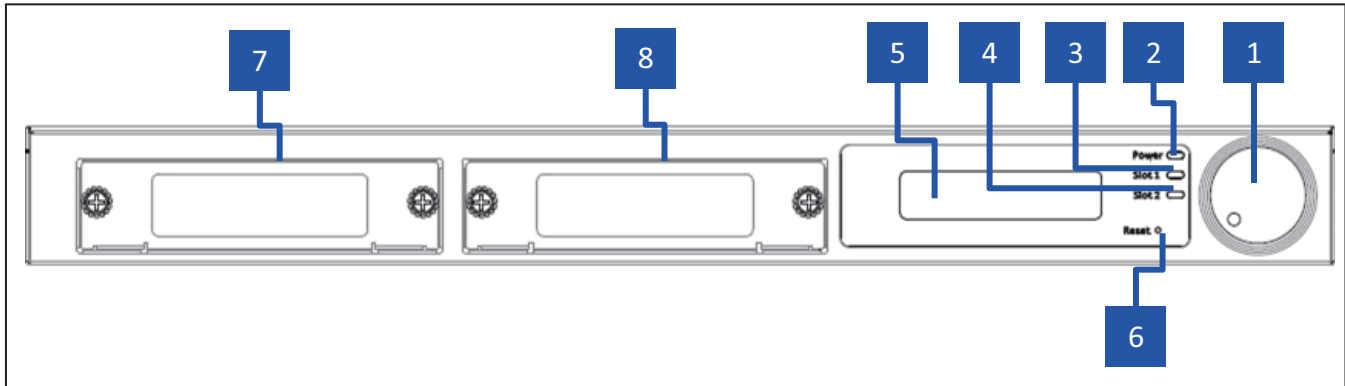

1. **Knob:** Knob with Push Button Switch
2. **PWR LED:** Power ON LED Indication
3. **Slot1 LED:** Slot 1 Status LED Indication
4. **Slot2 LED:** Slot 2 Status LED Indication
5. **LCM Display:** LCM Display for Setting and Information Retrieve
6. **Reset Button:** System Rest Button
7. **Module Slot 1:** Slot 1 Position
8. **Module Slot 2:** Slot 2 Position



## 5.2 Rear Panel

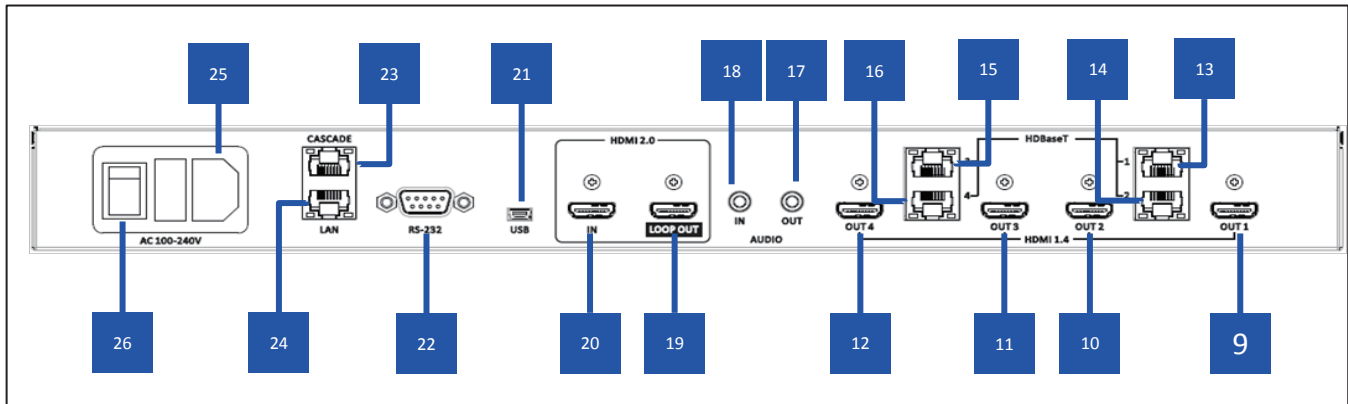



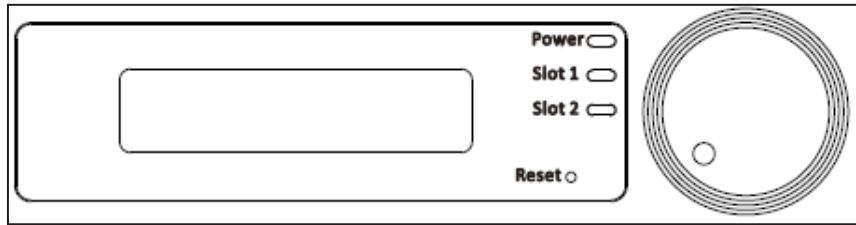

- 9. **HDMI Out 1:** HDMI 1.4a output port 1, is activated as module plug-in slot 1.
- 10. **HDMI Out 2:** HDMI 1.4a output port 2, is activated as module plug-in slot 1.
- 11. **HDMI Out 3:** HDMI 1.4a output port 3, is activated as module plug-in slot 2.
- 12. **HDMI Out 4:** HDMI 1.4a output port 4, is activated as module plug-in slot 2.
- 13. **HDBaseT Out 1:** HDBaseT Output Port 1, is activated as module with HDBT Card plug-in slot 1.
- 14. **HDBaseT Out 2:** HDBaseT Output Port 2, is activated as module with HDBT Card plug-in slot 1.
- 15. **HDBaseT Out 3:** HDBaseT Output Port 3, is activated as module with HDBT Card plug-in slot 2.
- 16. **HDBaseT Out 4:** HDBaseT Output Port 4, is activated as module with HDBT Card plug-in slot 2.
- 17. **Stereo audio output:** Stereo Audio Output
- 18. **Stereo audio Input:** Stereo Audio Input
- 19. **HDMI 2.0 Loop-Through Output:** HDMI 2.0 Loop Output Port, connect to next CS200T
- 20. **HDMI 2.0 Input:** HDMI 2.0 Input Port, connection with A/V source
- 21. **Mini USB Port:** Mini USB Port for Firmware Upgrade
- 22. **RS-232:** RS-232 control port, DTE Mode
- 23. **LAN Cascade Port:** Ethernet control port for cascade of CS200T
- 24. **LAN Port:** Ethernet control port
- 25. **AC Power Inlet:** AC 110/220V Power input
- 26. **Power Switch:** Power Switch

# 6 OPERATION APPROACH

## 6.1 Knob Control



Icon	Description	Action
	One Push	1. Enter Menu 2. Confirm setting
	Two-second Press	Back to upper menu
	Clockwise Rotation	1. Next Item 2. Value Increment
	Anti-Clockwise Rotation	1. Last Item 2. Value Decrement

## 6.1.1 LCM Menu Tree

Main level	2nd level	3rd level	Default Value	Notes
INFORMATION	Device Name	CS200T		Display Only
	FW Version	Cxx.xx		Display Only
	Module Name 1	CRP-2K/CRPT-2K/NONE		Display Only
	Module Name 2	CRP-2K/CRPT-2K/ NONE		Display Only
	Input Status	(Resolution) / No Connection / Not Support	No Connection	Display Only Resolution example:1024x768@60
	EDID Timing	3840x2160	3840x2160	
	Error Code	No Error	No Error	1. No Error 2. 00000001 ~ FFFFFFFF
	Exit			
NETWORK	DHCP	ON/OFF	OFF	
	IP Address	192.168.0.150	192.168.0.150	Display Only when DHCP ON
	Subnet Mask	255.255.255.0	255.255.255.0	
	Gateway	192.168.0.254	192.168.0.254	
	MAC	00-50-41-xx-xx-xx		Display Only
	Exit			
VIDEO	Output Timing	1024x768/1280x800/1920x720/ 1920x1080/1920x1200	1920x1080	
	Exit			
AUDIO	Volume	0~15	8	
	System Mute	ON/OFF	OFF	
	Exit			
CROPPING	Layout	1x1/1x2/1x3/1x4/2x2	1x1	
	H. Overlap	0~1920 (Unit: Pixel)	H. pixel of output timing	4 pixels scale for all output timing
	V. Overlap	0~1080 (Unit: Pixel)	V. pixel of output timing	4 pixels scale for all output timing
	Exit			
OPTIONS	Factory Reset	CANCEL / OK	CANCEL	
	LAN Standby Mode	OFF/LAN Standby	LAN Standby	
	LAN Standby Time	0 Min~60Min (Interval 5 Mins)	15 Min	
	Signal Power On	OFF/ON	OFF	
	Exit			

## 6.1.2 Initial Page

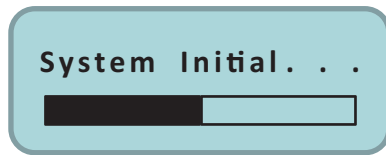

The system will take 10 seconds for initial.

## 6.1.3 Startup Page

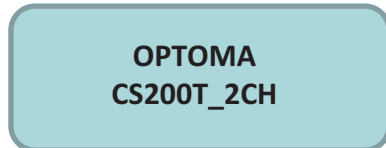

## 6.1.4 Main Page Flow

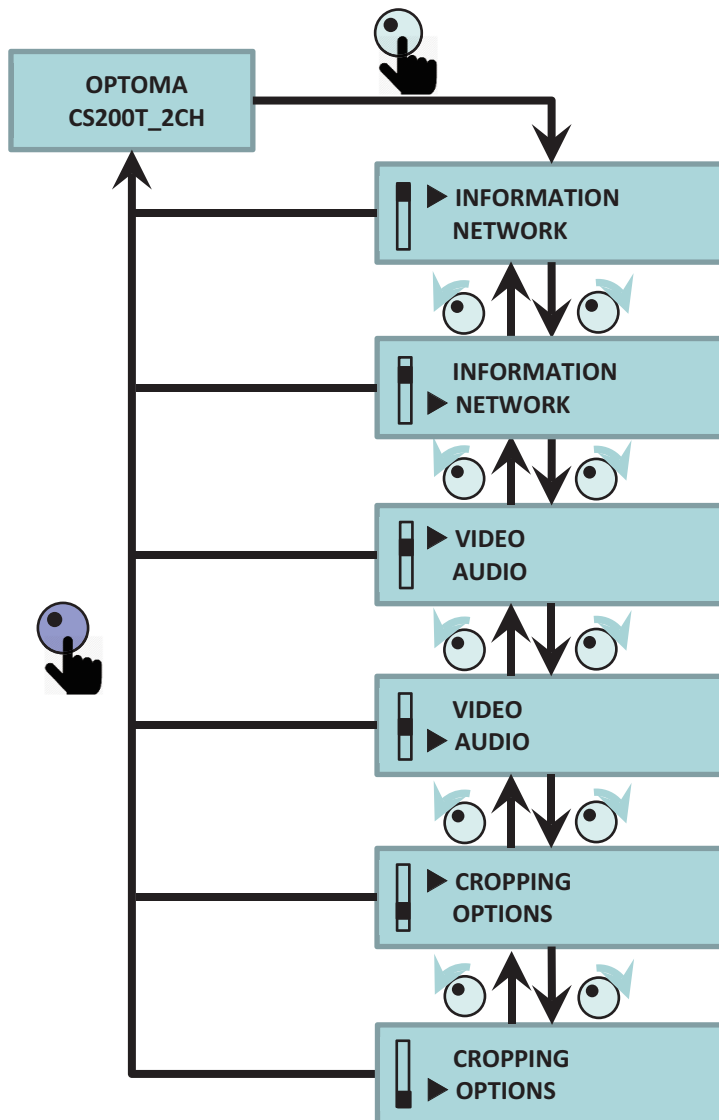

## 6.1.5 Information Page

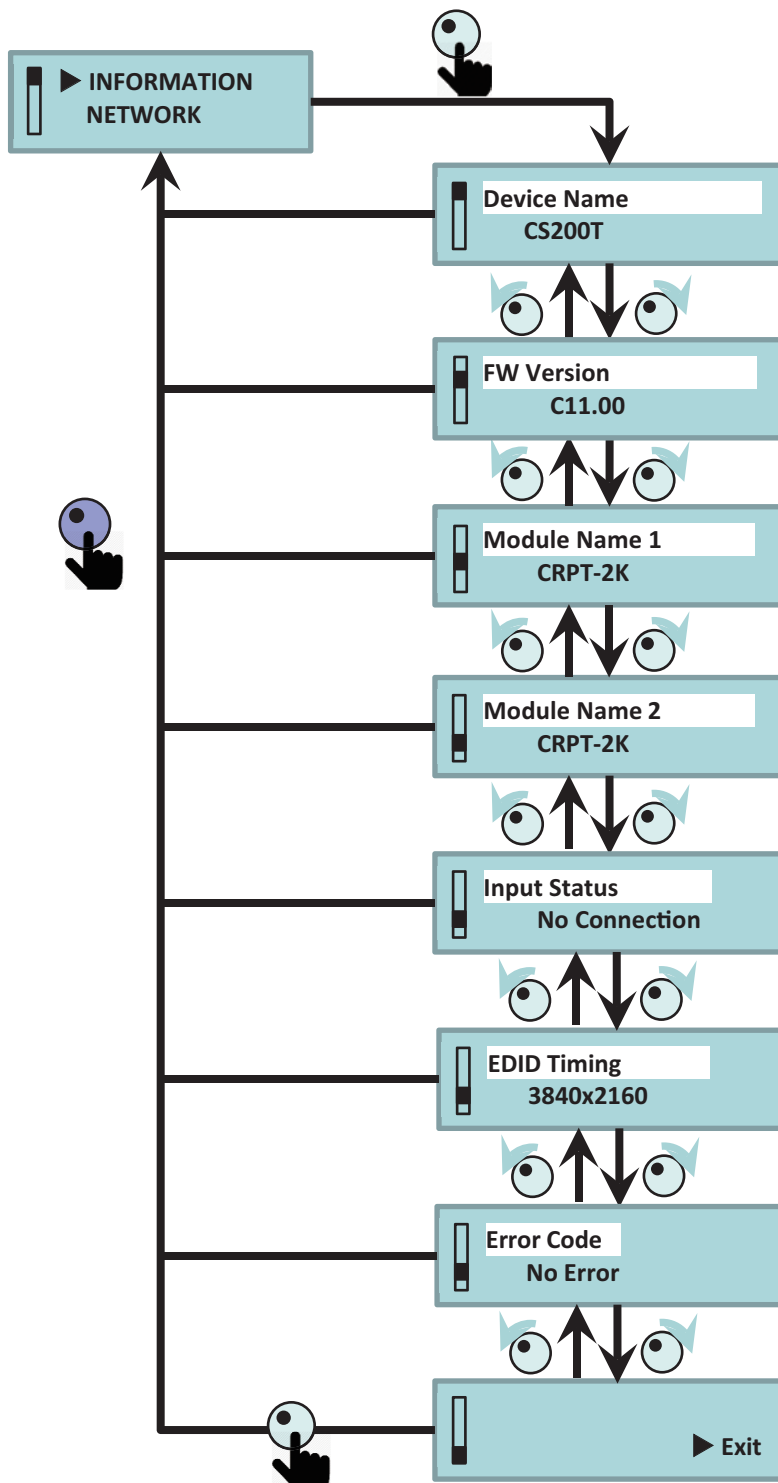

## 6.1.6 Network Page

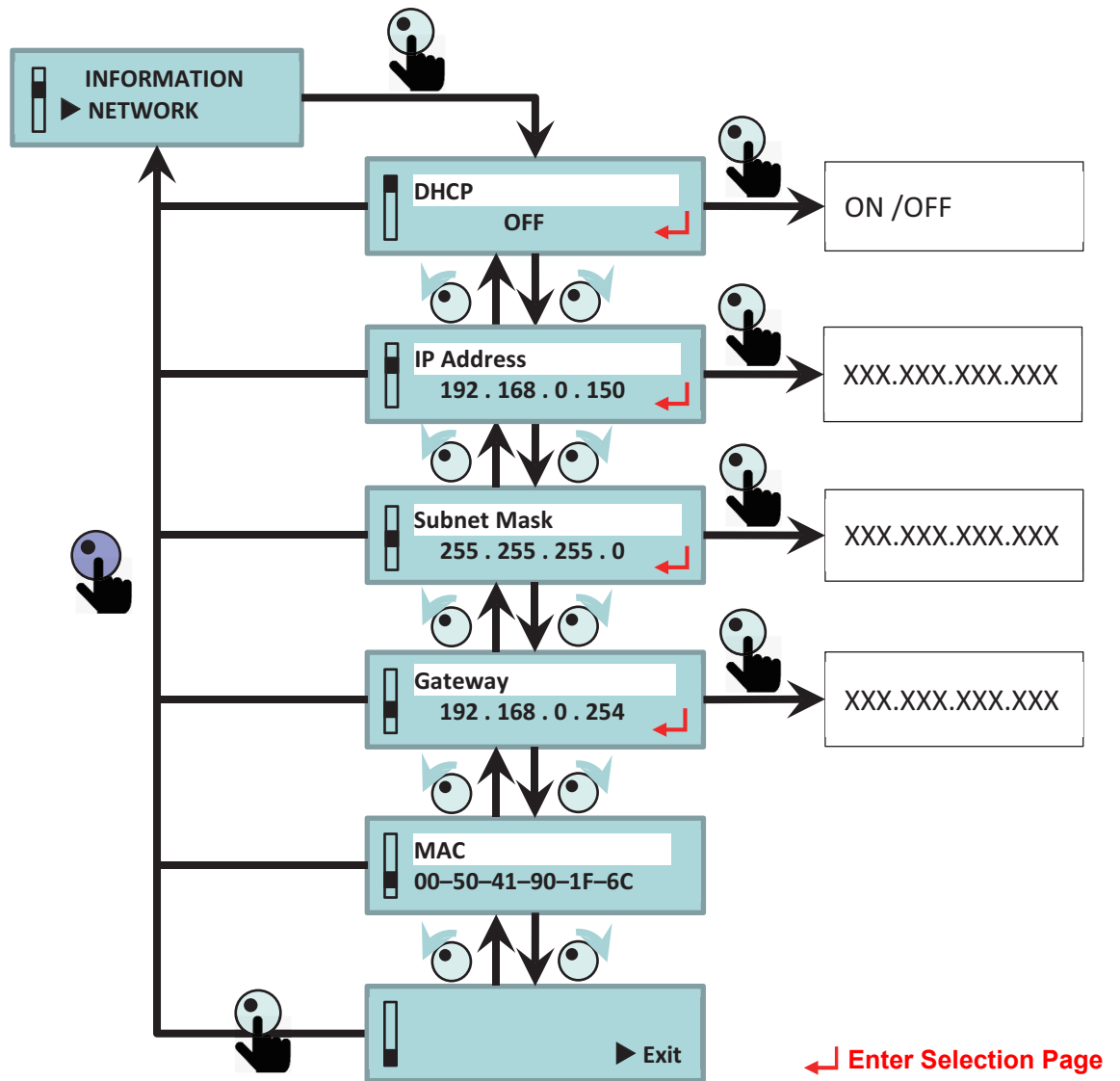

## 6.1.7 Video Page

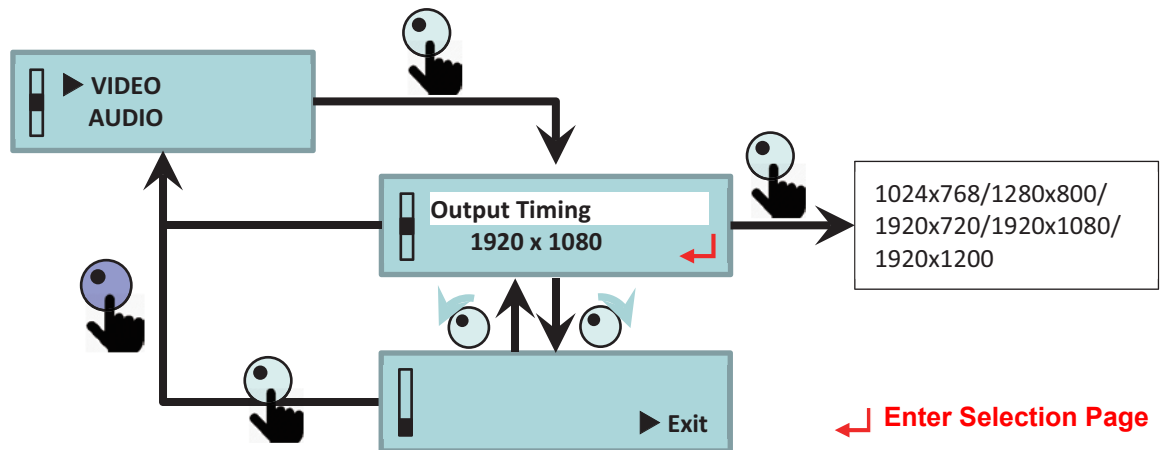

## 6.1.8 Audio Page

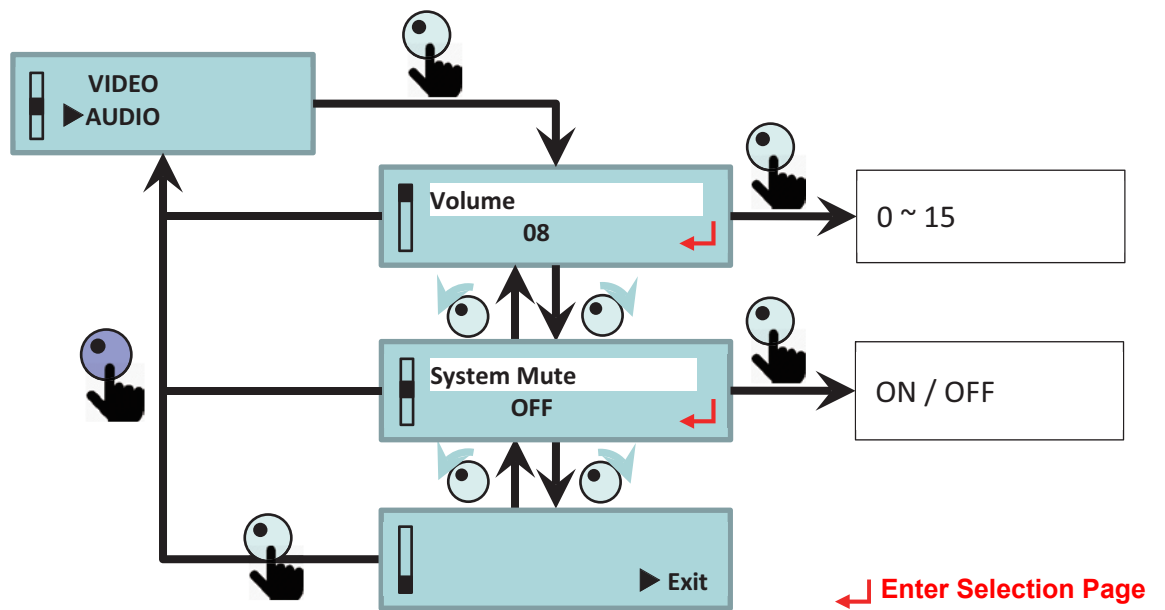

## 6.1.9 Cropping Page

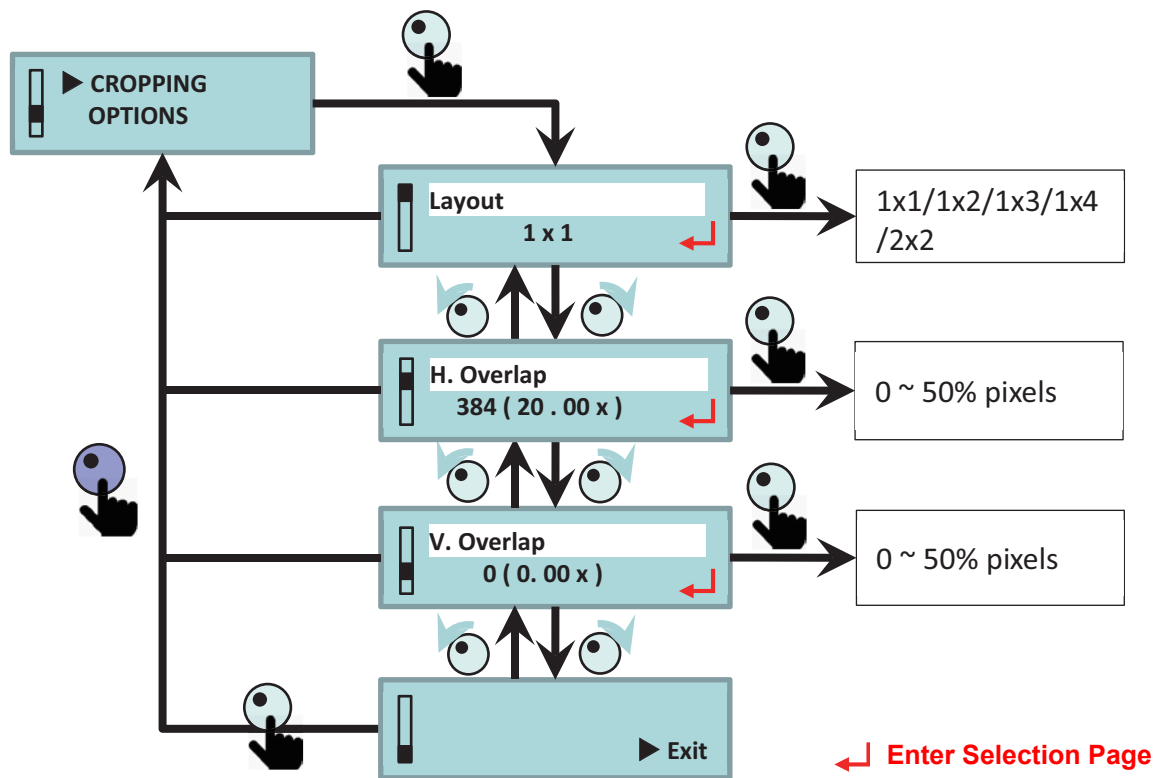



### 6.1.9.1 Layout & Overlap Description

Layout	Cropping Input Mapping				Overlap Width	
	CH 1	CH 2	CH 3	CH 4		
1x1					0 (Block)	0 (Block)
1x2					20%	0 (Block)
1x3				<b>Disable</b>	20%	0 (Block)
1x4					20%	0 (Block)
2x2					20%	20%
<b>Custom</b>	Specified Configuration (Only for AP)				0	0

- Layout 1x1 means output full input image.
- Overlap Width will be reset after Layout setting changed or Output timing changed.
- Output port will output solid **YELLOW** Color as port disabled.
- Output port will output solid **GREEN** color as no valid input timing.
- Cropping Setting by AP, Layout state will display “Custom”.
- The scale of Overlap Width is 4 pixel and range is 0~100% of image.

## 6.1.10 Options Page

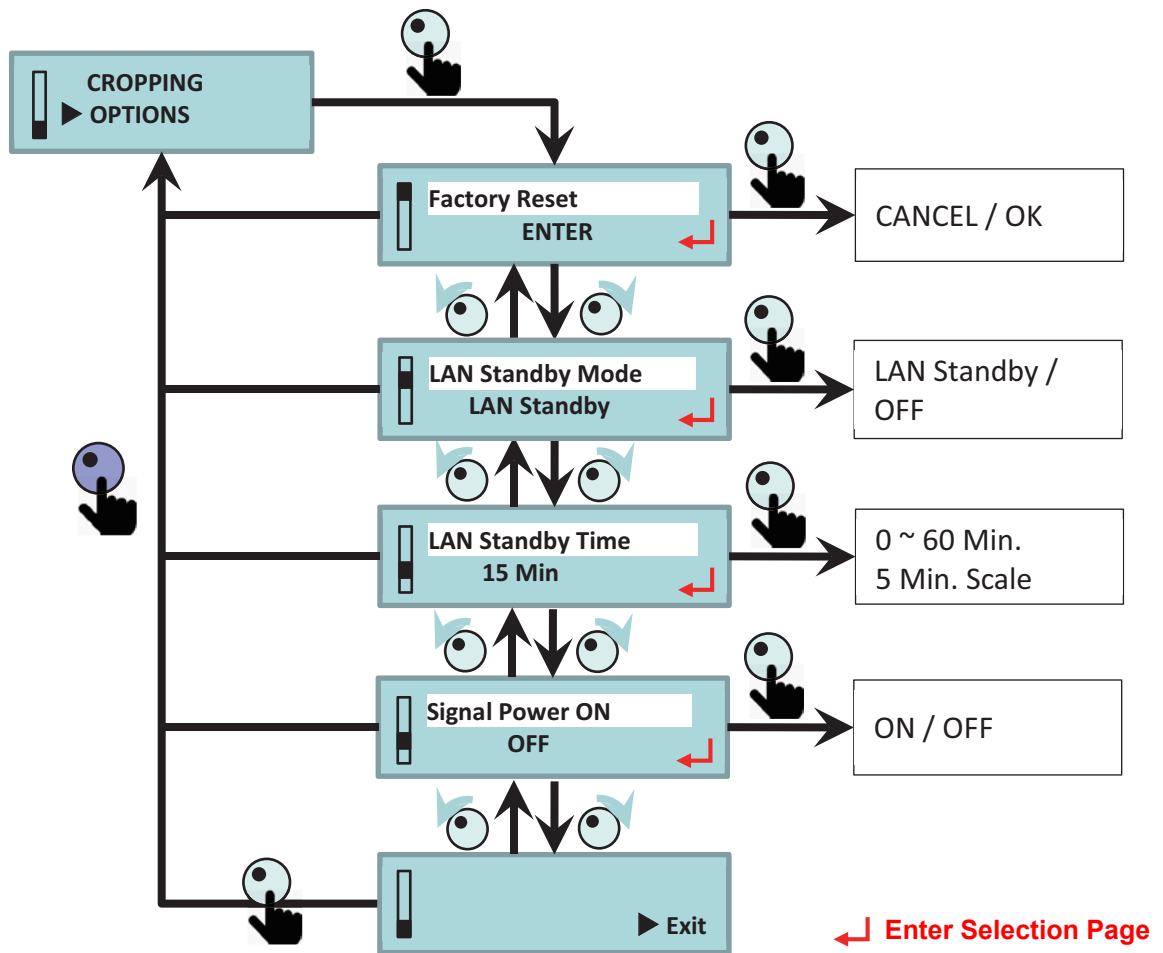

### 6.1.10.1 Standby and Signal Power On Description

LCM Menu		Wakeup Criteria			
Mode	Signal Power ON	HDMI Input Valid	RS-232 PWR ON Cmd	Knob Push	LAN (Telnet) PWR ON Cmd
Standby	OFF	X	V	V	X
	ON	V	V	V	X
LAN Standby	OFF	X	V	V	V
	ON	V	V	V	V

# 7 Regulation & Safety Notices

## FCC Notice:

This device complies with Part 15 of the FCC rules. Operation is subject to the following two conditions

- (1) This device may not cause harmful interference,
- (2) This device must accept any interference receive ; including interference that may cause undesired operation.

This Equipment has been tested and found to comply with the limits for a Class A digital device, pursuant to part 15 of the FCC Rules. These limits are designed to provide reasonable protection against harmful interference when the equipment is operated in a commercial environment. This equipment generates, uses, and can radiate radio frequency energy and, if not installed and used in accordance with the instruction manual, may cause harmful interference to radio communications.

Operation of this equipment in a residential area is likely to cause harmful interference in which case the user will be required to correct the interference at his own expense.

THIS DEVICE COMPLIES WITH FCC PART 15 AND ICES-003, CLASS A. REFER TO LABEL ON BOTTOM FOR ADDITIONAL DETAILS.

## Notice: Canadian users

CAN ICES-3(A) / NMB-3(A)

The Class A digital apparatus meets all requirements of the Canadian Interference-Causing Equipment Regulation. Interference-Causing Equipment Regulation.

Cet appareil numérique de la class A respecte toutes les exigences du Reglement sur le materiel brouilleur du Canada.

## CE Notice:

This product is herewith confirmed to comply with the requirements set out in the Council Directives on the Approximation of the laws of the Member States relating to Electromagnetic Compatibility Directive 2004/108/EEC.

### Warning

- This product must not be used in residential areas.
- This product may cause interference if used in residential areas.

Such use must be avoided unless the user takes special measures to reduce electromagnetic emissions to prevent interference to the reception of radio and television broadcasts.

## KC Notice:



이 기기는 업무용 환경에서 사용할 목적으로 적합성평가를 받은 기기로서 가정용 환경에서 사용하는 경우 전파간섭의 우려가 있습니다

# Optoma global offices

For service or support, please contact your local office.



## USA

Optoma Technology, Inc.  
47697 Westinghouse Drive.  
Fremont, Ca 94539  
www.optomausa.com

 888-289-6786  
 510-897-8601  
 [services@optoma.com](mailto:services@optoma.com)



## Canada

Optoma Technology, Inc.  
47697 Westinghouse Drive.  
Fremont, Ca 94539  
www.optomausa.com

 888-289-6786  
 510-897-8601  
 [services@optoma.com](mailto:services@optoma.com)

## Latin America

Optoma Technology, Inc.  
47697 Westinghouse Drive.  
Fremont, Ca 94539  
www.optomausa.com

 888-289-6786  
 510-897-8601  
 [services@optoma.com](mailto:services@optoma.com)



## Europe

Unit 1, Network 41, Bourne End Mills  
Hemel Hempstead, Herts  
HP1 2UJ, United Kingdom  
www.optoma.eu  
Service Tel : +44 (0)1923 691865

 +44 (0) 1923 691 800  
 +44 (0) 1923 691 888  
 [service@tsc-europe.com](mailto:service@tsc-europe.com)



## Benelux BV

Randstad 22-123  
1316 BW Almere  
The Netherlands  
www.optoma.nl

 +31 (0) 36 820 0252  
 +31 (0) 36 548 9052



## France

Bâtiment E  
81-83 avenue Edouard Vaillant  
92100 Boulogne Billancourt,  
France

 +33 1 41 46 12 20  
 +33 1 41 46 94 35  
 [savoptoma@optoma.fr](mailto:savoptoma@optoma.fr)



## Spain

C/ José Hierro,36 Of. 1C  
28522 Rivas VaciaMadrid,  
Spain

 +34 91 499 06 06  
 +34 91 670 08 32



## Deutschland

Wiesenstrasse 21 W  
D40549 Düsseldorf,  
Germany

 +49 (0) 211 506 6670  
 +49 (0) 211 506 66799  
 [info@optoma.de](mailto:info@optoma.de)

## Scandinavia



Lerpeveien 25  
3040 Drammen  
Norway

 +47 32 98 89 90  
 +47 32 98 89 99  
 [info@optoma.no](mailto:info@optoma.no)

PO.BOX 9515  
3038 Drammen  
Norway

## Korea

WOOMI TECH.CO.,LTD.  
4F,Minu Bldg.33-14, Kangnam-Ku,  
seoul,135-815, KOREA

 +82+2+34430004  
 +82+2+34430005



## Japan

東京都足立区綾瀬3-25-18  
株式会社オーエス  
コンタクトセンター:0120-380-495

 [info@os-worldwide.com](mailto:info@os-worldwide.com)  
www.os-worldwide.com



## Taiwan

12F., No.213,Sec. 3, Beixin Rd.,  
Xindian Dist., New Taipei City 231,  
Taiwan, R.O.C.  
www.optoma.com.tw

 +886-2-8911-8600  
 +886-2-8911-6550  
 [services@optoma.com.tw](mailto:services@optoma.com.tw)  
asia.optoma.com



## Hong Kong

Unit A, 27/F Dragon Centre,  
79 Wing Hong Street,  
Cheung Sha Wan,  
Kowloon, Hong Kong

 +852-2396-8968  
 +852-2370-1222  
www.optoma.com.hk

## China

5F, No. 1205, Kaixuan Rd.,  
Changning District  
Shanghai, 200052, China

 +86-21-62947376  
 +86-21-62947375  
www.optoma.com.cn

